



MetroLock Padlock

The Medeco MetroLock features a hardened, solid steel body, boron alloy shackle, dual ball bearing locking mechanism, and patent protected key control. The MetroLock is available in multiple shackle lengths to fit any vendor's specific requirements.

Every padlock cylinder is UL 437 Listed and can be keyed into any existing T-handle cylinder, cam lock, switch lock, or other Medeco 60 series system. The Medeco³ unique design provides triple locking action, making the locks virtually pickproof. All Medeco³ keys and locks are protected under patent trademark and copyright laws. Medeco³ keys may only be duplicated by Medeco or an authorized Medeco Service Center, and only at your request.



Benefits:

- ▼ Hardened stainless steel inserts inside the cylinder provide the ultimate defense against drill, pull, punch, and other forms of physical attack.
- ▼ Unique elevating and rotating tumbler pin system is virtually pick proof.
- ▼ Hardened solid steel, chrome plated body.
- ▼ All Medeco cylinders are constructed of durable machined brass components, designed to last the life of your equipment.
- ▼ Patented Medeco³ keys may only be duplicated by Medeco or authorized Medeco Service Center, and only at your request.
- ▼ MetroLock padlocks are completely serviceable, and can be re-keyed in case of lost or stolen keys.
- ▼ MetroLock padlocks can be keyed in with other 60 series products (10 series products may be keyed into existing 60 series systems).
- ▼ Locks can be keyed alike, keyed different, or master keyed depending on your specific needs.
- ▼ Available in a variety of different shackle lengths.

Applications:

MetroLock pad locks can be used a variety of different applications including vending, storage and transportation.

Warranty:

Warranted for two years against manufacturer's defects. See Medeco limited Warranty for full details.

Technical Information:

Body is chrome plated steel.

Shackles are 5/16" diameter Boron Alloy.

Available in 1", 2" and 3" shackle clearance.

Use Medeco 60 Series keying system.

Finishes:

26 Satin chrome finish standard. Other finishes available, depending on volume.



800.266.2646
www.coinsecurity.com
sales@coinsecurity.com

Ordering Instructions

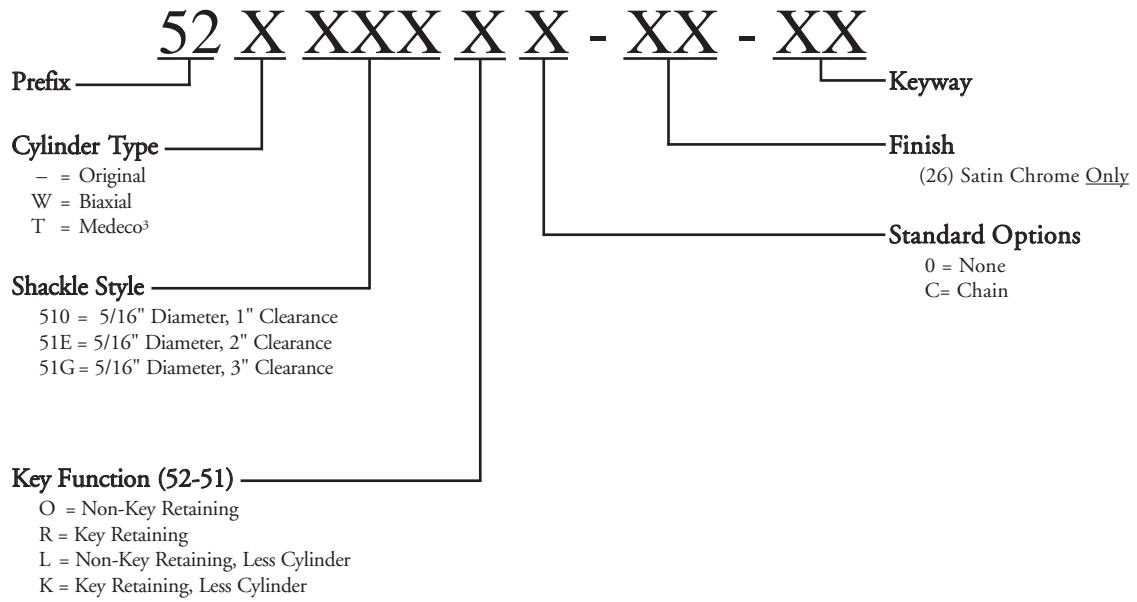

800.266.2646
www.coinsecurity.com
sales@coinsecurity.com

Technical Drawings

METRO PADLOCK

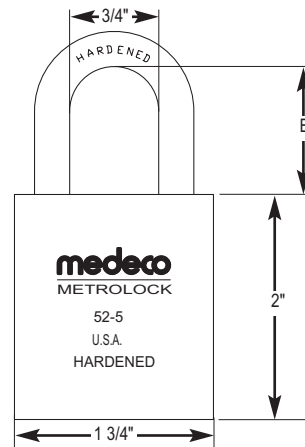

Part #	Shackle Diameter	Thickness	Shackle Clearance (B)
52T510	5/16"	1 1/8"	1
52T51E	5/16"	1 1/8"	2
52T51G	5/16"	1 1/8"	3



800.266.2646
www.coinsecurity.com
sales@coinsecurity.com

Medeco Padlocks

The new Medeco® padlock series is a complete line of premium high security or key control only padlocks that can be master keyed into most existing Medeco³ key systems using door hardware cylinders. This means Medeco padlocks can share the same key as the facility doors and utilize the same security principles.

These padlocks are available in three distinct body styles: **Weather Resistant, Shrouded Shackle, and Hockey Puck**. The protective shroud on the shrouded shackle model nearly eliminates the risk of having the shackle cut by a bolt cutter. The weather guard protects the padlock, its cylinder and other components from water, dust, and grime. The Hockey Puck is a shackle-less design for the highest level of protection against bolt cutter attacks.



Made of solid brass, the traditional padlock bodies are available in three different styles to accept different door hardware cylinders: knob-style, large format interchangeable core, and small format interchangeable core. The Hockey Puck bodies are constructed of solid steel with a black chrome finish.

Technical Information:

- ▼ Solid brass body provides strength and protection against forced attacks and outstanding resistance to the elements
- ▼ Boron alloy steel shackle resists cutting and pulling attacks
- ▼ Hardened stainless steel shackles available for enhanced corrosion resistance
- ▼ Thermoplastic body cover and cylinder dust cover on all models resist chemicals, water, heat, and scratching
- ▼ Weather seals around shackle legs prevent dirt, dust, water, and other contaminants from entering the padlock
- ▼ Solid cast iron shackle guard to protect against bolt cutter attacks provides maximum shackle protection on shrouded models. Shrouded models do not include weather seals
- ▼ Standard body padlocks use 6 Pin key-in-knob type cylinders
- ▼ Hockey Puck style padlocks use 5 Pin key-in-knob type cylinders

Warranty:

Warranted for two years against manufacturing defects. See Medeco Limited Warranty for full details



CoinSecuritySystems
 ASSET PROTECTION

800.266.2646
www.coinsecurity.com
sales@coinsecurity.com

Ordering Instructions

How To Order Padlocks

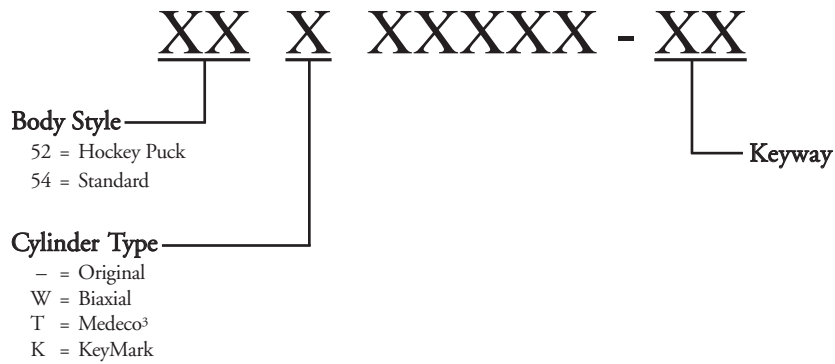
1. Select Part Number from the charts on the following pages.
2. Select the cylinder type.
3. Specify the keyway.



800.266.2646
www.coinsecurity.com
sales@coinsecurity.com

Indoor/Outdoor Padlock With 5/16" Diameter Boron Alloy Steel Shackle

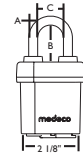

Description	Part Number	Shackle Dimensions		
		A	B	C
Indoor/Outdoor Padlock, Non-Key Retaining, 1 1/8" Shackle Clearance, With Cylinder	54X51500 -	5/16"	1 1/8"	7/8"
Indoor/Outdoor Padlock, Key Retaining, 1 1/8" Shackle Clearance, With Cylinder	54X515R0 -	5/16"	1 1/8"	7/8"
Indoor/Outdoor Padlock, Non-Key Retaining, 2 3/8" Shackle Clearance, With Cylinder	54X51F00 -	5/16"	2 3/8"	7/8"
System Series Padlock, Key Retaining, 2 3/8" Shackle Clearance, With Cylinder	54X51FR0 -	5/16"	2 3/8"	7/8"
Less Cylinder Description	Part Number	A	B	C
Indoor/Outdoor Padlock, Non-Key Retaining, 1 1/8" Shackle Clearance, Less Cylinder	54-515L0 -	5/16"	1 1/8"	7/8"
Indoor/Outdoor Padlock, Key Retaining, 1 1/8" Shackle Clearance, Less Cylinder	54-515K0 -	5/16"	1 1/8"	7/8"
Indoor/Outdoor Padlock, Non-Key Retaining, 2 3/8" Shackle Clearance, Less Cylinder	54-51FL0 -	5/16"	2 3/8"	7/8"
Indoor/Outdoor Padlock, Key Retaining, 2 3/8" Shackle Clearance, Less Cylinder	54-51FK0 -	5/16"	2 3/8"	7/8"

Indoor/Outdoor Padlock With 7/16" Diameter Boron Alloy Steel Shackle

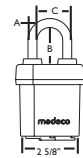

Description	Part Number	Shackle Dimensions		
		A	B	C
Indoor/Outdoor Padlock, Non-Key Retaining, 1 3/8" Shackle Clearance, With Cylinder	54X71500 -	7/16"	1 3/8"	7/8"
Indoor/Outdoor Padlock, Key Retaining, 1 3/8" Shackle Clearance, With Cylinder	54X715R0 -	7/16"	1 3/8"	7/8"
Indoor/Outdoor Padlock, Non-Key Retaining, 1 7/8" Shackle Clearance, With Cylinder	54X71F00 -	7/16"	1 7/8"	7/8"
Indoor/Outdoor Padlock, Key Retaining, 1 7/8" Shackle Clearance, With Cylinder	54X71FR0 -	7/16"	1 7/8"	7/8"
Less Cylinder Description	Part Number	A	B	C
Indoor/Outdoor Padlock, Non-Key Retaining, 1 3/8" Shackle Clearance, Less Cylinder	54-715L0 -	7/16"	1 3/8"	7/8"
Indoor/Outdoor Padlock, Key Retaining, 1 3/8" Shackle Clearance, Less Cylinder	54-715K0 -	7/16"	1 3/8"	7/8"
Indoor/Outdoor Padlock, Non-Key Retaining, 1 7/8" Shackle Clearance, Less Cylinder	54-71FL0 -	7/16"	1 7/8"	7/8"
Indoor/Outdoor Padlock, Key Retaining, 1 7/8" Shackle Clearance, Less Cylinder	54-71FK0 -	7/16"	1 7/8"	7/8"



800.266.2646
www.coinsecurity.com
sales@coinsecurity.com

Shrouded Indoor/Outdoor Padlock With 5/16" Diameter Boron Alloy Steel Shackle

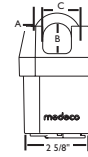

Description	Part Number	Shackle Dimensions		
		A	B	C
Shrouded Indoor/Outdoor Padlock, Non-Key Retaining, 3/4" Shackle Clearance, With Cylinder	54X52500 -	5/16"	3/4"	7/8"
Shrouded Indoor/Outdoor Padlock, Key Retaining, 3/4" Shackle Clearance, With Cylinder	54X525R0 -	5/16"	3/4"	7/8"
Less Cylinder Description		Shackle Dimensions		
Description	Part Number	A	B	C
Shrouded Indoor/Outdoor Padlock, Non-Key Retaining, 3/4" Shackle Clearance, Less Cylinder	54-525L0 -	5/16"	3/4"	7/8"
Shrouded Indoor/Outdoor Padlock, Key Retaining, 3/4" Shackle Clearance, Less Cylinder	54-525K0 -	5/16"	3/4"	7/8"

Shrouded Indoor/Outdoor Padlock With 7/16" Diameter Shackle

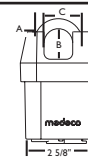

Description	Part Number	Shackle Dimensions		
		A	B	C
Shrouded Indoor/Outdoor Padlock, Non-Key Retaining, 3/4" Shackle Clearance, With Cylinder	54X72500 -	7/16"	3/4"	7/8"
Shrouded Indoor/Outdoor Padlock, Key Retaining, 3/4" Shackle Clearance, With Cylinder	54X725R0 -	7/16"	3/4"	7/8"

52-9 Series Hockey Puck Padlock



Description	Part Number
Hockey Puck Padlock, Key Retaining	52X93000

Padlock Cylinders

MEDECO ³ Premium High Security Description	Part Number
6 Pin Cylinder for Medeco Padlock	51-0600 -
5 Pin Cylinder for Hockey Puck Style Padlock	20-0160-XX



800.266.2646
 www.coinsecurity.com
 sales@coinsecurity.com

Components**Part Number**

Component Package for Medeco Padlocks, Non Key Retaining. Includes: CP-130510 Cylinder Extension/Actuator, Spring & Washer, CP-022030 Cylinder Retainer, CP-011511-000 Retainer Screw, CP-250140 Steel Ball Bearing	94-0199
--	---------

Cylinder Retainer Sleeve (Fits Over Cylinder Bible Chamber & Holds Cylinder in Padlock Body)	CP-022030
---	-----------

Retainer Screw, #6-32 UNC-2A x .312" Length	CP-011511-000
---	---------------

Cylinder Extension/Actuator, Non Key Retaining, Spring & Washer for 54 Series Padlocks,	CP-130510
--	-----------

Stainless Steel Ball Bearing for 54 Series Padlocks, .360" Diameter	CP-250140
--	-----------

Cylinder Extension/Actuator, Key Retaining, for 54 Series Padlocks	CP-200720
---	-----------

**Shackles for Indoor/
Outdoor Padlocks****Boron Alloy Steel
Part Number****Stainless Steel
Part Number**

Standard Shackle for 54-51 Indoor/Outdoor Padlock, 1-1/8" Shackle Clearance x 5/16" Diameter	CP-144120	CP-144180
---	-----------	-----------

Extra Length Shackle for 54-51 Indoor/Outdoor Padlock, 2-3/8" Shackle Clearance x 5/16" Diameter	CP-144130	CP-144190
---	-----------	-----------

Standard Shackle for 54-71 Indoor/Outdoor Padlock, 1-3/8" Shackle Clearance x 7/16" Diameter	CP-144150	CP-144210
---	-----------	-----------

Extra Length Shackle for 54-71 Indoor/Outdoor Padlock, 1-7/8" Shackle Clearance x 7/16" Diameter	CP-144160	CP-144220
---	-----------	-----------

**Shackles for
Shrouded Padlocks****Boron Alloy Steel
Part Number****Stainless Steel
Part Number**

Standard Shackle for 54-52 Shrouded Padlock, 3/4" Shackle Clearance x 5/16" Diameter	CP-144110	CP-144170
---	-----------	-----------

Standard Shackle for 54-72 Shrouded Padlock, 3/4" Shackle Clearance x 7/16" Diameter	CP-144140	CP-144200
---	-----------	-----------



800.266.2646

www.coinsecurity.com

sales@coinsecurity.com



The G8R Series Padlock

Built to Thrive in Harsh Climates

With its tough, water resistant construction, the Medeco *G8R Series* is the padlock to choose for extreme environments like trailers, cargo containers, and gates.

The padlock body is constructed of solid stainless steel. You can choose either a stainless steel shackle for maximum corrosion resistance, or hardened steel to withstand severe physical attack. Each padlock includes a weather-seal cap attached by a steel cable. An optional finish plate is also included for applications that do not require a water resistant seal.

Benefits:

- ◆ Sealed construction protects cylinders from water and road grime
- ◆ Stainless steel body resists attack and corrosion
- ◆ Shackles can be specified in hardened or stainless steel to fit your application

Applications:

The G8R Series padlock was designed for locking installations requiring weather resistance and strong physical security. Applications include cargo containers, trailer doors, gates, and vending machines.



Warranty:

Warranted for two years against manufacturer's defects. See Medeco limited Warranty for full details.

Technical Information:

Body is cast from 300 series Stainless Steel. Stainless Steel shackles use 300 series stainless. Hardened shackles use case-hardened steel

Padlocks are sold less cylinder. Compatible with all NEXGEN electronic T-handle cylinders, and Medeco mechanical T-handle cylinders

Padlocks are sold with weather-seal cap attached by a steel cable. A finish plate is included for use in applications that do not require the weather-seal cap

Ordering Information

52 - 1XXX 40

Shackle Type and Size

- 10 = 5/16" Stainless Steel
- 11 = 5/16" Hardened Steel
- 20 = 7/16" Stainless Steel
- 21 = 7/16" Hardened Steel

The G8R Series Padlock can be used with either mechanical or electronic cylinders. An optional cover plate is included for applications that do not require a weather proof cap.



Technical Drawings

PADLOCK DIMENSIONS

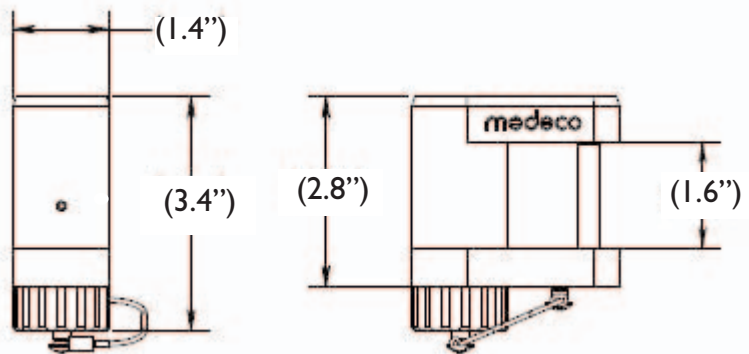

Coin Security Systems
ASSET PROTECTION

800.266.2646
www.coinsecurity.com
sales@coinsecurity.com

medeco[®]
HIGH SECURITY LOCKS